

Sett./Sect. 1	C.O./T.C. 1	TORRI DEL BENACO	Km. 30,800	Media/Average 33,60
	C.O./T.C. 2	CAPRINO VERONESE	Tempo Imposto /Target Time 0h 55'	

Roadbook by CronoCarService

Distanza/Distance		DIREZIONE/DIRECTION	INFORMAZ./INFORMAT.	Dist. Tot. Regress.
Totale/Total	Parz./Part			
0,000	0,000		 PARTENZA TORRI DEL BENACO Viale F.lli Lavanda	30,800
3,150	3,150			27,650
5,900	2,750			24,900
7,100	1,200			23,700
8,000	0,900			22,800
Segue	0,100	Senza indicazioni, proseguire diritto / Without indication, go straight ahead		Pag. 1



Sett./Sect. 1	C.O./T.C. 1	TORRI DEL BENACO	Km. 30,800	Media/Average 33,60
	C.O./T.C. 2	CAPRINO VERONESE	Tempo Imposto /Target Time 0h 55'	

Roadbook by CronoCarService

Distanza/Distance		DIREZIONE/DIRECTION	INFORMAZ./INFORMAT.	Dist. Tot. Regress.
Totale/Total	Parz./Part			
8,100	0,100	<div style="display: flex; align-items: center;"> <div style="border: 1px solid black; padding: 2px; margin-right: 5px;">1</div> </div>	<div style="border: 1px solid black; padding: 5px; width: fit-content; margin: auto;">Via L. Pincini</div>	22,700
8,350	0,250	<div style="display: flex; align-items: center;"> <div style="border: 1px solid black; padding: 2px; margin-right: 5px;">2</div> </div>	<div style="border: 1px solid black; padding: 5px; width: fit-content; margin: auto;">Via Cirillo Salaorni</div>	22,450
8,600	0,250	<div style="display: flex; align-items: center;"> <div style="border: 1px solid black; padding: 2px; margin-right: 5px;">3</div> </div>	entrata parcheggio	22,200
8,700	0,100	<div style="display: flex; align-items: center;"> <div style="border: 1px solid black; padding: 2px; margin-right: 5px;">4</div> </div>	<div style="border: 1px solid black; padding: 5px; width: fit-content; margin: auto;"> </div>	22,100
		<div style="display: flex; align-items: center;"> <div style="border: 1px solid black; padding: 2px; margin-right: 5px;">5</div> </div>		
Segue	0,000	Senza indicazioni, proseguire diritto / Without indication, go straight ahead		Pag. 2

1	Sett./Sect.	C.O./T.C.	TORRI DEL BENACO	Km.	Media/Average
		1		30,800	33,60
	C.O./T.C.	C.O./T.C.	CAPRINO VERONESE	Tempo Imposto /Target Time	
	2	2		0h 55'	

Roadbook by CronoCarService

Distanza/Distance		DIREZIONE/DIRECTION	INFORMAZ./INFORMAT.	Dist. Tot. Regress.
Totale/Total	Parz./Part			

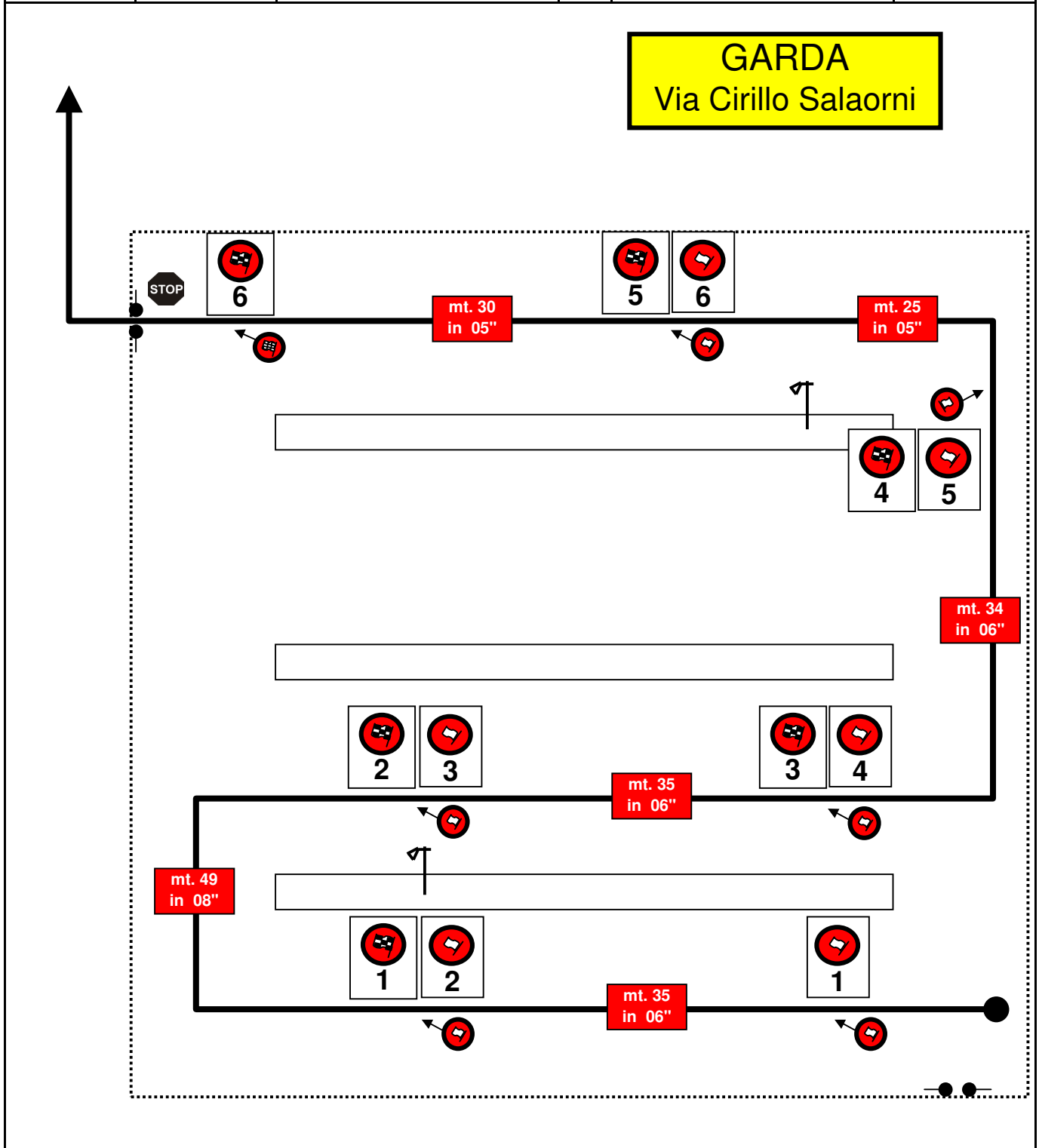

1	Sett./Sect.	C.O./T.C.	TORRI DEL BENACO	Km.	Media/Average
		1		30,800	33,60
	C.O./T.C.		CAPRINO VERONESE	Tempo Imposto /Target Time	
	2			0h	55'

Roadbook by CronoCarService

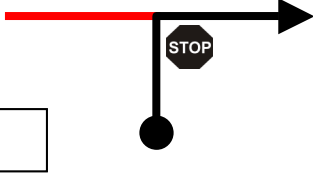
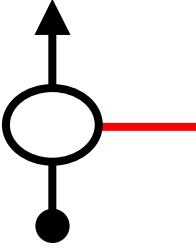
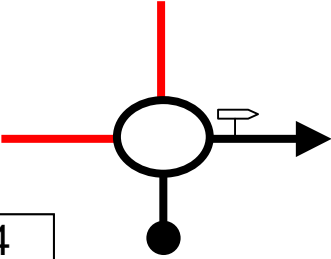
Distanza/Distance		DIREZIONE/DIRECTION	INFORMAZ./INFORMAT.	Dist. Tot. Regress.
Totale/Total	Parz./Part			
9,050	0,142	<div style="display: flex; align-items: center; justify-content: center;"> <div style="border: 1px solid black; padding: 2px; margin-right: 5px;">1</div>  <div style="margin-left: 10px;">↑ ↓</div> </div>		21,750
9,600	0,550	<div style="display: flex; align-items: center; justify-content: center;"> <div style="border: 1px solid black; padding: 2px; margin-right: 5px;">2</div>  </div>		21,200
9,700	0,100	<div style="display: flex; align-items: center; justify-content: center;"> <div style="border: 1px solid black; padding: 2px; margin-right: 5px;">3</div> <div style="text-align: center;"> <div style="border: 1px solid black; padding: 2px;">COSTERMANO</div> <div style="width: 20px; height: 20px; margin: 0 auto; border-bottom: 1px solid black;"></div> </div> </div>		21,100
11,700	2,000	<div style="display: flex; align-items: center; justify-content: center;"> <div style="border: 1px solid black; padding: 2px; margin-right: 5px;">4</div>  </div>	<div style="display: flex; flex-direction: column; align-items: center;"> <div style="background-color: green; color: white; padding: 2px 5px; margin-bottom: 2px;">Autostrada</div> <div style="background-color: blue; color: white; padding: 2px 5px; margin-bottom: 2px;">Affi</div> <div style="background-color: blue; color: white; padding: 2px 5px;">Bardolino</div> </div>	19,100
13,000	1,300	<div style="display: flex; align-items: center; justify-content: center;"> <div style="border: 1px solid black; padding: 2px; margin-right: 5px;">5</div> <div style="text-align: center;"> <div style="border: 1px solid black; padding: 2px;">ALBARE'</div> <div style="width: 20px; height: 20px; margin: 0 auto; border-bottom: 1px solid black;"></div> </div> </div>		17,800
Segue	0,500	Senza indicazioni, proseguire diritto / Without indication, go straight ahead		Pag.4

Sett./Sect. 1	C.O./T.C. 1	TORRI DEL BENACO	Km. 30,800	Media/Average 33,60
	C.O./T.C. 2	CAPRINO VERONESE	Tempo Imposto /Target Time 0h 55'	

Roadbook by CronoCarService

Distanza/Distance		DIREZIONE/DIRECTION	INFORMAZ./INFORMAT.	Dist. Tot. Regress.
Totale/Total	Parz./Part			
13,500	0,500	 1		17,300
15,200	1,700	 2		15,600
15,700	0,500	 3		15,100
15,970	0,270	 4	Via Pozzo dell'Amore CT 1	14,830
17,100	1,130	 5	 Autostrada ↑ Garda ↑ Caprino ↑	13,700
Segue	0,700	Senza indicazioni, proseguire diritto / Without indication, go straight ahead		Pag.5

Sett./Sect. 1	C.O./T.C. 1	TORRI DEL BENACO	Km. 30,800	Media/Average 33,60
	C.O./T.C. 2	CAPRINO VERONESE	Tempo Imposto /Target Time 0h 55'	





Roadbook by CronoCarService

Distanza/Distance		DIREZIONE/DIRECTION	INFORMAZ./INFORMAT.	Dist. Tot. Regress.
Totale/Total	Parz./Part			
17,800	0,700		Via Strada del Bra	13,000
17,900	0,100			12,900
17,950	0,050			12,850
18,010	0,060			12,790
18,080	0,070			12,720
Segue	0,060	Senza indicazioni, proseguire diritto / Without indication, go straight ahead		Pag.6

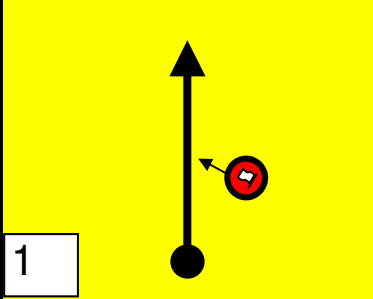
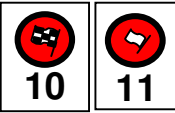
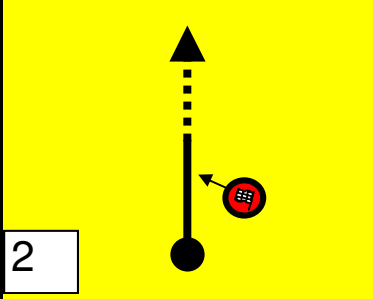

Sett./Sect. 1	C.O./T.C. 1	TORRI DEL BENACO	Km. 30,800	Media/Average 33,60
	C.O./T.C. 2	CAPRINO VERONESE	Tempo Imposto /Target Time 0h 55'	

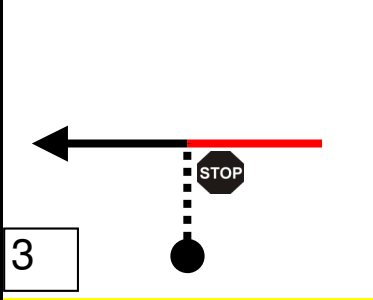
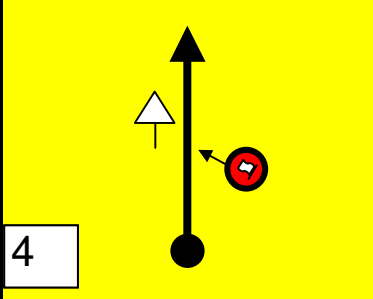
Roadbook by CronoCarService

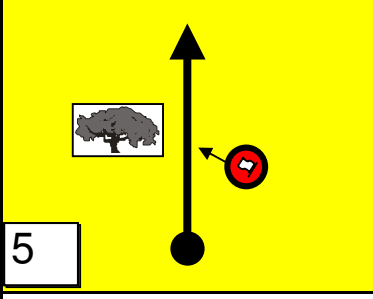
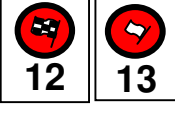
Distanza/Distance		DIREZIONE/DIRECTION	INFORMAZ./INFORMAT.	Dist. Tot. Regress.
Totale/Total	Parz./Part			
18,140	0,060			12,660
18,210	0,070		 segue inizio sterrato	12,590
18,410	0,200		fine sterrato	12,390
18,475	0,065		 cartello rovesciato	12,325
18,540	0,065			12,260
Segue	0,060	Senza indicazioni, proseguire diritto / Without indication, go straight ahead		Pag.7



Sett./Sect. 1	C.O./T.C. 1	TORRI DEL BENACO	Km. 30,800	Media/Average 33,60
	C.O./T.C. 2	CAPRINO VERONESE	Tempo Imposto /Target Time 0h 55'	

Roadbook by CronoCarService

Distanza/Distance		DIREZIONE/DIRECTION	INFORMAZ./INFORMAT.	Dist. Tot. Regress.
Totale/Total	Parz./Part			
18,600	0,060			12,200
18,670	0,070			12,130
18,730	0,060			12,070
18,780	0,050			12,020
18,850	0,070			11,950
Segue	0,450	Senza indicazioni, proseguire dritto / Without indication, go straight ahead		Pag.8

Sett./Sect. 1	C.O./T.C. 1	TORRI DEL BENACO	Km. 30,800	Media/Average 33,60
	C.O./T.C. 2	CAPRINO VERONESE	Tempo Imposto /Target Time 0h 55'	

Roadbook by CronoCarService

Distanza/Distance		DIREZIONE/DIRECTION	INFORMAZ./INFORMAT.	Dist. Tot. Regress.
Totale/Total	Parz./Part			
19,300	0,450	<p>1</p>	non entrare in autostrada	11,500
19,400	0,100	<p>2</p>		11,400
20,900	1,500	<p>3</p>		9,900
21,900	1,000	<p>4</p>		8,900
23,450	1,550	<p>5</p>		7,350
Segue	0,150	Senza indicazioni, proseguire diritto / Without indication, go straight ahead		Pag.9



Sett./Sect. 1	C.O./T.C. 1	TORRI DEL BENACO	Km. 30,800	Media/Average 33,60
	C.O./T.C. 2	CAPRINO VERONESE	Tempo Imposto /Target Time 0h 55'	

Roadbook by CronoCarService

Distanza/Distance		DIREZIONE/DIRECTION	INFORMAZ./INFORMAT.	Dist. Tot. Regress.
Totale/Total	Parz./Part			
23,600	0,150			7,200
23,650	0,050			7,150
23,720	0,070			7,080
23,790	0,070			7,010
23,840	0,050			6,960
Segue	0,040	Senza indicazioni, proseguire diritto / Without indication, go straight ahead		Pag.10



Sett./Sect. 1	C.O./T.C. 1	TORRI DEL BENACO	Km. 30,800	Media/Average 33,60
	C.O./T.C. 2	CAPRINO VERONESE	Tempo Imposto /Target Time 0h 55'	

Roadbook by CronoCarService

Distanza/Distance		DIREZIONE/DIRECTION	INFORMAZ./INFORMAT.	Dist. Tot. Regress.
Totale/Total	Parz./Part			
23,880	0,040	<div style="background-color: yellow; padding: 5px;"> </div>	Via Venerque 21	6,920
24,100	0,220			6,700
24,650	0,550			6,150
25,900	1,250			4,900
28,600	2,700			2,200
Segue	0,200	Senza indicazioni, proseguire diritto / Without indication, go straight ahead		Pag.11

1	Sett./Sect.	C.O./T.C.	TORRI DEL BENACO	Km.	Media/Average
		1		30,800	33,60
	C.O./T.C.		CAPRINO VERONESE	Tempo Imposto /Target Time	
	2			0h	55'

Roadbook by CronoCarService

Distanza/Distance		DIREZIONE/DIRECTION	INFORMAZ./INFORMAT.	Dist. Tot. Regress.
Totale/Total	Parz./Part			
28,800	0,200		<div style="border: 1px solid black; padding: 5px; display: inline-block;"> </div> <p>albero dei 100 bersaglieri che trovarono rifugio tra i suoi rami</p>	2,000
29,300	0,500			1,500
29,500	0,200			1,300
30,700	1,200			0,100
30,750	0,050			0,050
Segue	0,050	Senza indicazioni, proseguire diritto / Without indication, go straight ahead		Pag.12



1	Sett./Sect.	C.O./T.C.	TORRI DEL BENACO	Km.	Media/Average
		1		30,800	33,60
	C.O./T.C.	CAPRINO VERONESE		Tempo Imposto /Target Time	
	2			0h	55'

Roadbook by CronoCarService

Distanza/Distance		DIREZIONE/DIRECTION	INFORMAZ./INFORMAT.	Dist. Tot. Regress.
Totale/Total	Parz./Part			
30,800	0,050		 sosta prevista circa 10' parcheggiare nella piazza in attesa del CO	0,000
		2		
		3		
		4		
		5		
Segue	0,000	Senza indicazioni, proseguire diritto / Without indication, go straight ahead		Pag.13



Sett./Sect. 2	C.O./T.C. 2	CAPRINO VERONESE	Km. 21,200	Media/Average 13,39
	C.O./T.C. 3	TORRI DEL BENACO	Tempo Imposto /Target Time 1h 35'	

Roadbook by CronoCarService

Distanza/Distance		DIREZIONE/DIRECTION	INFORMAZ./INFORMAT.	Dist. Tot. Regress.
Totale/Total	Parz./Part			
0,000	0,000	<p>1</p>	<p>2</p>	21,200
0,100	0,100	<p>2</p>		21,100
0,400	0,300	<p>3</p>		20,800
6,300	5,900	<p>4</p>		14,900
6,750	0,450	<p>5</p>		14,450
Segue	0,200	Senza indicazioni, proseguire diritto / Without indication, go straight ahead		Pag.14

2	Sett./Sect.	C.O./T.C.	CAPRINO VERONESE	Km.	21,200	Media/Average	13,39
			2				
		C.O./T.C.	TORRI DEL BENACO	Tempo Imposto /Target Time		1h 35'	
			3				

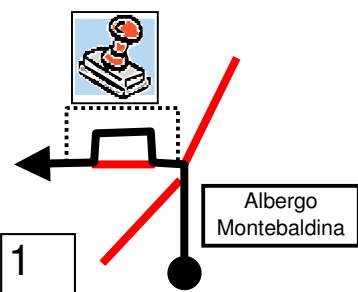
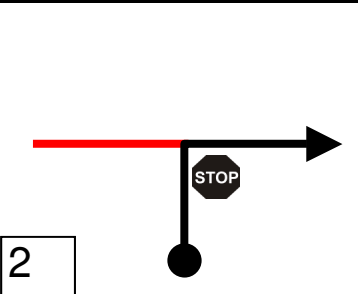
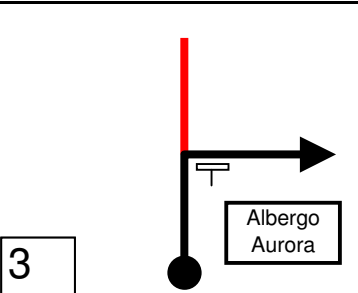
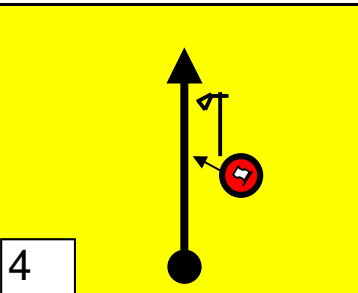
Roadbook by CronoCarService

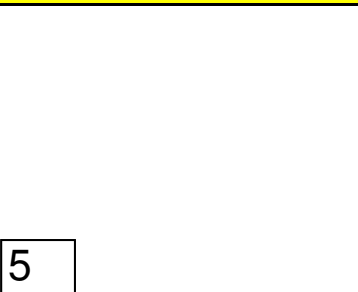
Distanza/Distance		DIREZIONE/DIRECTION	INFORMAZ./INFORMAT.	Dist. Tot. Regress.
Totale/Total	Parz./Part			
6,950	0,200		CT 2	14,250
7,400	0,450			13,800
10,600	3,200		<div style="border: 1px solid black; padding: 2px;">Via Val Masson</div>	10,600
10,800	0,200			10,400
				
Segue	0,000	Senza indicazioni, proseguire diritto / Without indication, go straight ahead		Pag.15

Sett./Sect. 2	C.O./T.C. 2	CAPRINO VERONESE	Km. 21,200	Media/Average 13,39
	C.O./T.C. 3	TORRI DEL BENACO	Tempo Imposto /Target Time 1h 35'	

Roadbook by CronoCarService

Distanza/Distance		DIREZIONE/DIRECTION	INFORMAZ./INFORMAT.	Dist. Tot. Regress.
Totale/Total	Parz./Part			
Segue	2,800	Senza indicazioni, proseguire diritto / Without indication, go straight ahead		Pag.16

Sett./Sect. 2	C.O./T.C. 2	CAPRINO VERONESE	Km. 21,200	Media/Average 13,39
	C.O./T.C. 3	TORRI DEL BENACO	Tempo Imposto /Target Time 1h 35'	

Roadbook by CronoCarService

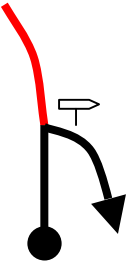
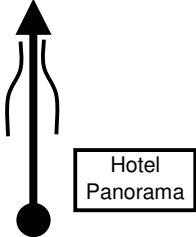
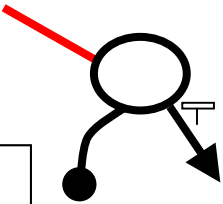
Distanza/Distance		DIREZIONE/DIRECTION	INFORMAZ./INFORMAT.	Dist. Tot. Regress.
Totale/Total	Parz./Part			
13,700	2,800	<div style="border: 1px solid black; padding: 5px; display: inline-block;">1</div> 	<div style="border: 1px solid black; padding: 5px; display: inline-block; background-color: #0056b3; color: white;">Albisano</div> <div style="border: 1px solid black; padding: 5px; display: inline-block; background-color: #0056b3; color: white;">Torri del Benaco</div> <div style="border: 1px solid black; padding: 5px; display: inline-block; background-color: #8b4513; color: white;">Lago di Garda</div>	7,500
15,000	1,300	<div style="border: 1px solid black; padding: 5px; display: inline-block;">2</div> <div style="border: 1px solid black; padding: 5px; display: inline-block; margin-left: 20px;">ALBISANO</div>		6,200
16,400	1,400	<div style="border: 1px solid black; padding: 5px; display: inline-block;">3</div> 	<div style="text-align: center;">!!!</div> <p>strettoia: procedere a passo d'uomo</p>	4,800
17,100	0,700	<div style="border: 1px solid black; padding: 5px; display: inline-block;">4</div> 	<div style="text-align: center;">!!!</div> <div style="border: 1px solid black; padding: 5px; display: inline-block; margin-left: 20px;">Via per Albisano</div>	4,100
19,100	2,000	<div style="border: 1px solid black; padding: 5px; display: inline-block;">5</div> <div style="border: 1px solid black; padding: 5px; display: inline-block; margin-left: 20px;">TORRI DEL BENACO</div>		2,100
Segue	1,800	Senza indicazioni, proseguire diritto / Without indication, go straight ahead		Pag.17

2	Sett./Sect.	C.O./T.C.	CAPRINO VERONESE	Km.	21,200	Media/Average	13,39
		C.O./T.C.	TORRI DEL BENACO	Tempo Imposto /Target Time	1h 35'		

Roadbook by CronoCarService

Distanza/Distance		DIREZIONE/DIRECTION	INFORMAZ./INFORMAT.	Dist. Tot. Regress.
Totale/Total	Parz./Part			
20,900	1,800			0,300
21,200	0,300		<div style="border: 1px solid black; padding: 2px; width: fit-content; margin: auto;">Viale F.lli Lavanda</div>	0,000
		<p>parcheggiare per visita al castello e rinfresco presso l'HOTEL GARDESANA in attesa del C.O.</p>		
		<div style="border: 1px solid black; padding: 2px; width: 30px; margin: auto;">4</div>		
		<div style="border: 1px solid black; padding: 2px; width: 30px; margin: auto;">5</div>		
Segue	0,000	Senza indicazioni, proseguire diritto / Without indication, go straight ahead		

Sett./Sect. 3	C.O./T.C. 3	TORRI DEL BENACO	Km. 32,600	Media/Average 32,60
	C.O./T.C. 4	CAPRINO VERONESE	Tempo Imposto /Target Time 1h 00'	



Roadbook by CronoCarService

Distanza/Distance		DIREZIONE/DIRECTION	INFORMAZ./INFORMAT.	Dist. Tot. Regress.
Totale/Total	Parz./Part			
0,000	0,000	<div style="border: 1px solid black; padding: 2px; display: inline-block;">1</div>	<div style="border: 1px solid black; padding: 2px; display: inline-block;">3</div>	32,600
3,150	3,150	<div style="border: 1px solid black; padding: 2px; display: inline-block;">2</div>		29,450
5,900	2,750	<div style="border: 1px solid black; padding: 2px; display: inline-block;">3</div>		26,700
7,100	1,200	<div style="border: 1px solid black; padding: 2px; display: inline-block;">4</div>		25,500
8,000	0,900	<div style="border: 1px solid black; padding: 2px; display: inline-block;">5</div>		24,600
Segue	0,100	Senza indicazioni, proseguire diritto / Without indication, go straight ahead		Pag.19

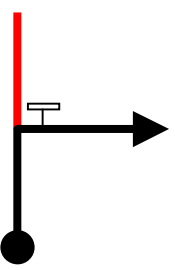
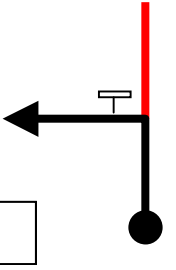
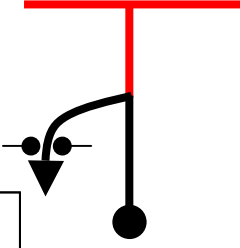
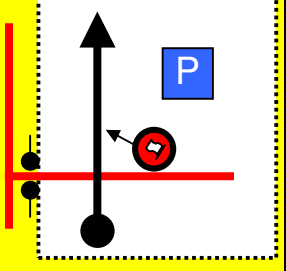

Sett./Sect. 3	C.O./T.C. 3	TORRI DEL BENACO	Km. 32,600	Media/Average 32,60
	C.O./T.C. 4	CAPRINO VERONESE	Tempo Imposto /Target Time 1h 00'	

Roadbook by CronoCarService

Distanza/Distance		DIREZIONE/DIRECTION	INFORMAZ./INFORMAT.	Dist. Tot. Regress.
Totale/Total	Parz./Part			
8,100	0,100	<div style="display: flex; align-items: center;"> <div style="border: 1px solid black; padding: 2px; margin-right: 5px;">1</div>  <div style="margin-left: 10px;">↑ ↓</div> </div>	<div style="border: 1px solid black; padding: 5px; width: fit-content; margin: auto;">Via L. Pincini</div>	24,500
8,350	0,250	<div style="display: flex; align-items: center;"> <div style="border: 1px solid black; padding: 2px; margin-right: 5px;">2</div>  </div>	<div style="border: 1px solid black; padding: 5px; width: fit-content; margin: auto;">Via Cirillo Salaorni</div>	24,250
8,600	0,250	<div style="display: flex; align-items: center;"> <div style="border: 1px solid black; padding: 2px; margin-right: 5px;">3</div>  </div>	entrata parcheggio	24,000
8,700	0,100	<div style="display: flex; align-items: center;"> <div style="border: 1px solid black; padding: 2px; margin-right: 5px;">4</div>  </div>	<div style="border: 1px solid black; padding: 5px; width: fit-content; margin: auto;">  25 </div>	23,900
		<div style="border: 1px solid black; padding: 2px; margin-right: 5px;">5</div>		
Segue	0,000	Senza indicazioni, proseguire diritto / Without indication, go straight ahead		Pag.20

Sett./Sect. 3	C.O./T.C. 3	TORRI DEL BENACO	Km. 32,600	Media/Average 32,60
	C.O./T.C. 4	CAPRINO VERONESE	Tempo Imposto /Target Time 1h 00'	

Roadbook by CronoCarService

Distanza/Distance		DIREZIONE/DIRECTION	INFORMAZ./INFORMAT.	Dist. Tot. Regress.
Totale/Total	Parz./Part			

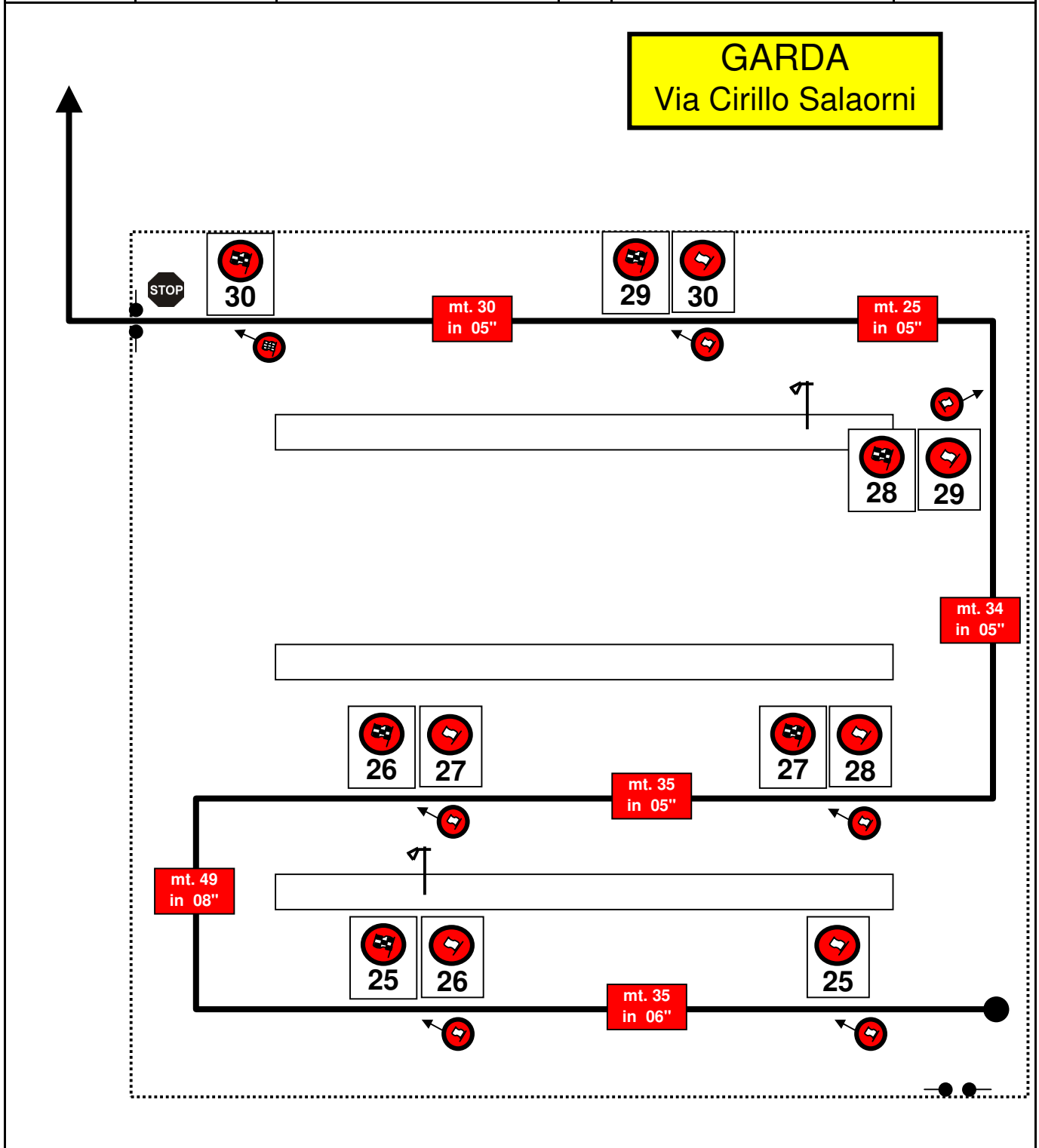

Sett./Sect. 3	C.O./T.C. 3	TORRI DEL BENACO	Km. 32,600	Media/Average 32,60
	C.O./T.C. 4	CAPRINO VERONESE	Tempo Imposto /Target Time 1h 00'	

Roadbook by CronoCarService

Distanza/Distance		DIREZIONE/DIRECTION	INFORMAZ./INFORMAT.	Dist. Tot. Regress.
Totale/Total	Parz./Part			
9,050	0,142		↑ ↓	23,550
9,150	0,100			23,450
10,000	0,850			22,600
10,200	0,200			22,400
12,700	2,500			19,900
Segue	0,500	Senza indicazioni, proseguire diritto / Without indication, go straight ahead		Pag.22

Sett./Sect. 3	C.O./T.C. 3	TORRI DEL BENACO	Km. 32,600	Media/Average 32,60
	C.O./T.C. 4	CAPRINO VERONESE	Tempo Imposto /Target Time 1h 00'	

Roadbook by CronoCarService

Distanza/Distance		DIREZIONE/DIRECTION	INFORMAZ./INFORMAT.	Dist. Tot. Regress.
Totale/Total	Parz./Part			
13,200	0,500	<div style="text-align: center;"> </div>	<div style="text-align: center;"> </div>	19,400
13,600	0,400	<div style="text-align: center;"> </div>	<div style="text-align: center;"> </div>	19,000
14,200	0,600	<div style="text-align: center;"> </div>	<div style="text-align: center;"> </div>	18,400
18,500	4,300	<div style="text-align: center;"> </div>	<div style="text-align: center;"> </div>	14,100
19,400	0,900	<div style="text-align: center;"> </div>	<div style="text-align: center;"> </div>	13,200
Segue	0,700	Senza indicazioni, proseguire diritto / Without indication, go straight ahead		Pag.23

Sett./Sect. 3	C.O./T.C. 3	TORRI DEL BENACO	Km. 32,600	Media/Average 32,60
	C.O./T.C. 4	CAPRINO VERONESE	Tempo Imposto /Target Time 1h 00'	

Roadbook by CronoCarService

Distanza/Distance		DIREZIONE/DIRECTION	INFORMAZ./INFORMAT.	Dist. Tot. Regress.
Totale/Total	Parz./Part			
20,100	0,700	<div style="border: 1px solid black; padding: 2px;">1</div>	<ul style="list-style-type: none"> <li style="background-color: #00FF00; padding: 2px; margin-bottom: 2px;">Autostrada <li style="background-color: #0000FF; padding: 2px; margin-bottom: 2px;">Garda <li style="background-color: #0000FF; padding: 2px;">Caprino 	12,500
20,600	0,500	<div style="border: 1px solid black; padding: 2px;">2</div>	<div style="border: 1px solid black; padding: 2px; width: fit-content;">Via Strada del Bra</div>	12,000
20,700	0,100	<div style="border: 1px solid black; padding: 2px;">3</div>	<div style="border: 1px solid black; padding: 2px; width: fit-content;">31</div>	11,900
20,750	0,050	<div style="border: 1px solid black; padding: 2px;">4</div>	<div style="display: flex; justify-content: space-around; align-items: center;"> <div style="border: 1px solid black; padding: 2px; width: 30px; height: 30px; text-align: center;">31</div> <div style="border: 1px solid black; padding: 2px; width: 30px; height: 30px; text-align: center;">32</div> </div>	11,850
20,810	0,060	<div style="border: 1px solid black; padding: 2px;">5</div>	<div style="display: flex; justify-content: space-around; align-items: center;"> <div style="border: 1px solid black; padding: 2px; width: 30px; height: 30px; text-align: center;">32</div> <div style="border: 1px solid black; padding: 2px; width: 30px; height: 30px; text-align: center;">33</div> </div>	11,790
Segue	0,070	Senza indicazioni, proseguire diritto / Without indication, go straight ahead		Pag.24



Sett./Sect. 3	C.O./T.C. 3	TORRI DEL BENACO	Km. 32,600	Media/Average 32,60
	C.O./T.C. 4	CAPRINO VERONESE	Tempo Imposto /Target Time 1h 00'	

Roadbook by CronoCarService

Distanza/Distance		DIREZIONE/DIRECTION	INFORMAZ./INFORMAT.	Dist. Tot. Regress.
Totale/Total	Parz./Part			
20,880	0,070	<p>1</p>		11,720
20,940	0,060	<p>2</p>		11,660
21,010	0,070	<p>3</p>	 segue inizio sterrato	11,590
21,210	0,200	<p>4</p>	fine sterrato	11,390
21,275	0,065	<p>5</p>	 cartello rovesciato	11,325
Segue	0,065	Senza indicazioni, proseguire diritto / Without indication, go straight ahead		Pag.25



Sett./Sect. 3	C.O./T.C. 3	TORRI DEL BENACO	Km. 32,600	Media/Average 32,60
	C.O./T.C. 4	CAPRINO VERONESE	Tempo Imposto /Target Time 1h 00'	

Roadbook by CronoCarService

Distanza/Distance		DIREZIONE/DIRECTION	INFORMAZ./INFORMAT.	Dist. Tot. Regress.
Totale/Total	Parz./Part			
21,340	0,065	 1	 36 37	11,260
21,400	0,060	 2	 37 38	11,200
21,470	0,070	 3	 38 39	11,130
21,530	0,060	 4	 39 40	11,070
21,580	0,050	 5	 40	11,020
Segue	0,070	Senza indicazioni, proseguire diritto / Without indication, go straight ahead		Pag.26





Sett./Sect. 3	C.O./T.C. 3	TORRI DEL BENACO	Km. 32,600	Media/Average 32,60
	C.O./T.C. 4	CAPRINO VERONESE	Tempo Imposto /Target Time 1h 00'	

Roadbook by CronoCarService

Distanza/Distance		DIREZIONE/DIRECTION	INFORMAZ./INFORMAT.	Dist. Tot. Regress.
Totale/Total	Parz./Part			
21,650	0,070	<div style="text-align: center;"> </div>	!!!	10,950
22,100	0,450	<div style="text-align: center;"> </div>	non entrare in autostrada	10,500
22,200	0,100	<div style="text-align: center;"> </div>	<div style="border: 1px solid black; background-color: blue; color: white; padding: 5px; text-align: center;"> Verona Domegliara Sant'Ambrogio ↓ </div>	10,400
23,700	1,500	<div style="text-align: center;"> </div>	<div style="display: flex; flex-direction: column; gap: 5px;"> <div style="border: 1px solid black; background-color: blue; color: white; padding: 2px 5px;">Rivoli</div> <div style="border: 1px solid black; background-color: blue; color: white; padding: 2px 5px;">Caprino V.se</div> <div style="border: 1px solid black; background-color: blue; color: white; padding: 2px 5px;">Brentino</div> <div style="border: 1px solid black; background-color: blue; color: white; padding: 2px 5px;">Trento</div> </div>	8,900
24,700	1,000	<div style="text-align: center;"> </div>	<div style="border: 1px solid black; background-color: white; padding: 2px 5px; display: inline-block;"> © Rivoli V.se </div>	7,900
Segue	1,550	Senza indicazioni, proseguire dritto / Without indication, go straight ahead		Pag.27

Sett./Sect. 3	C.O./T.C. 3	TORRI DEL BENACO	Km. 32,600	Media/Average 32,60
	C.O./T.C. 4	CAPRINO VERONESE	Tempo Imposto /Target Time 1h 00'	

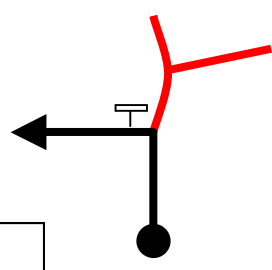
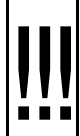
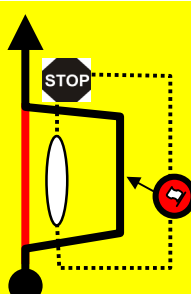
Roadbook by CronoCarService

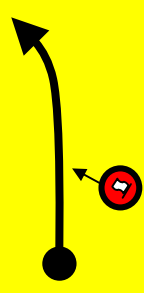
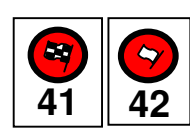
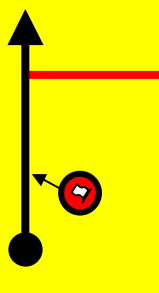
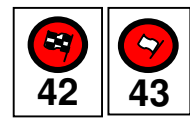
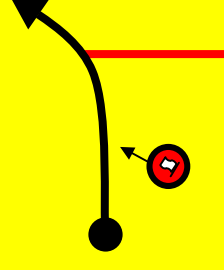
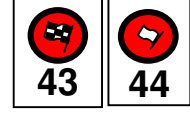
Distanza/Distance		DIREZIONE/DIRECTION	INFORMAZ./INFORMAT.	Dist. Tot. Regress.
Totale/Total	Parz./Part			
26,250	1,550	 1	 Via Brol	6,350
26,400	0,150	 2	 41	6,200
26,450	0,050	 3	 41 42	6,150
26,520	0,070	 4	 42 43	6,080
26,590	0,070	 5	 43 44	6,010
Segue	0,050	Senza indicazioni, proseguire diritto / Without indication, go straight ahead		Pag.28



Sett./Sect. 3	C.O./T.C. 3	TORRI DEL BENACO	Km. 32,600	Media/Average 32,60
	C.O./T.C. 4	CAPRINO VERONESE	Tempo Imposto /Target Time 1h 00'	

Roadbook by CronoCarService

Distanza/Distance		DIREZIONE/DIRECTION	INFORMAZ./INFORMAT.	Dist. Tot. Regress.
Totale/Total	Parz./Part			
26,640	0,050	<div style="border: 1px solid black; background-color: yellow; padding: 5px;"> </div>		5,960
26,680	0,040	<div style="border: 1px solid black; background-color: yellow; padding: 5px;"> </div>	<p>Via Venerque</p>	5,920
26,900	0,220			5,700
27,450	0,550			5,150
28,200	0,750			4,400
Segue	0,600	Senza indicazioni, proseguire diritto / Without indication, go straight ahead		Pag.29

3	Sett./Sect.	C.O./T.C.	TORRI DEL BENACO	Km.	Media/Average
		3		32,600	32,60
	C.O./T.C.		CAPRINO VERONESE	Tempo Imposto /Target Time	
	4			1h 00'	

Roadbook by CronoCarService

Distanza/Distance		DIREZIONE/DIRECTION	INFORMAZ./INFORMAT.	Dist. Tot. Regress.
Totale/Total	Parz./Part			
28,800	0,600	<div style="border: 1px solid black; padding: 2px; width: fit-content; margin: 0 auto;">CRISTANE</div>		3,800
30,300	1,500			2,300
31,400	1,100	<div style="border: 1px solid black; padding: 2px; width: fit-content; margin: 0 auto;">CAPRINO VERONESE</div>		1,200
31,700	0,300		<div style="border: 1px solid black; padding: 2px; width: fit-content; margin: 0 auto;">Caprino V.se </div>	0,900
32,100	0,400			0,500
Segue	0,300	Senza indicazioni, proseguire diritto / Without indication, go straight ahead		Pag.30

3	Sett./Sect.	C.O./T.C.	TORRI DEL BENACO	Km.	Media/Average
		3		32,600	32,60
	C.O./T.C.	CAPRINO VERONESE	Tempo Imposto /Target Time		
	4		1h 00'		

Roadbook by CronoCarService

Distanza/Distance		DIREZIONE/DIRECTION	INFORMAZ./INFORMAT.	Dist. Tot. Regress.
Totale/Total	Parz./Part			
32,400	0,300	 1		0,200
32,530	0,130	 2		0,070
32,580	0,050	 3		0,020
32,600	0,020	 4	 	0,000
		<p>parcheggiare in piazza della Vittoria e raggiungere a piedi il Ristorante "ATHENA" in piazza Sandro Pertini per il pranzo di commiato e le premiazioni</p>		
Segue	0,000	Senza indicazioni, proseguire diritto / Without indication, go straight ahead		Pag.31